

# Smartcards

**Erik Poll**

**Digital Security**

**Radboud University Nijmegen**

# Applications of smartcards & RFID tags



“Payment”

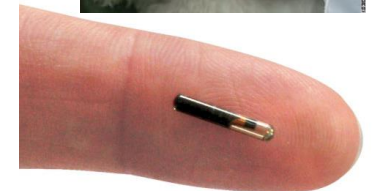

“ID”

# Exit smart cards?



mobile payments



mDL  
(mobile Driving License)

This may use **secure hardware inside the mobile phone:**  
**Apple Secure Enclave** or **Android hardware-backed keystore**

# Why use smartcards?



# Why use smartcards?



- *What are the security objectives?*
- *What are the capabilities of the smartcard that let it realise these objectives?*
- *How are these security objectives guaranteed?*
- *What are the security assumptions all this relies on?*

# Security objectives

- **Identification** of the card and/or the card holder
- **Authentication** of the card and/or the card holder
- **Non-repudiation** of some action
  - In Dutch: onweerlegbaarheid
- **Integrity** – of the **software** & **data** on the card
- **Confidentiality** – esp. of the **data** on the card

# How to achieve authentication or non-repudiation

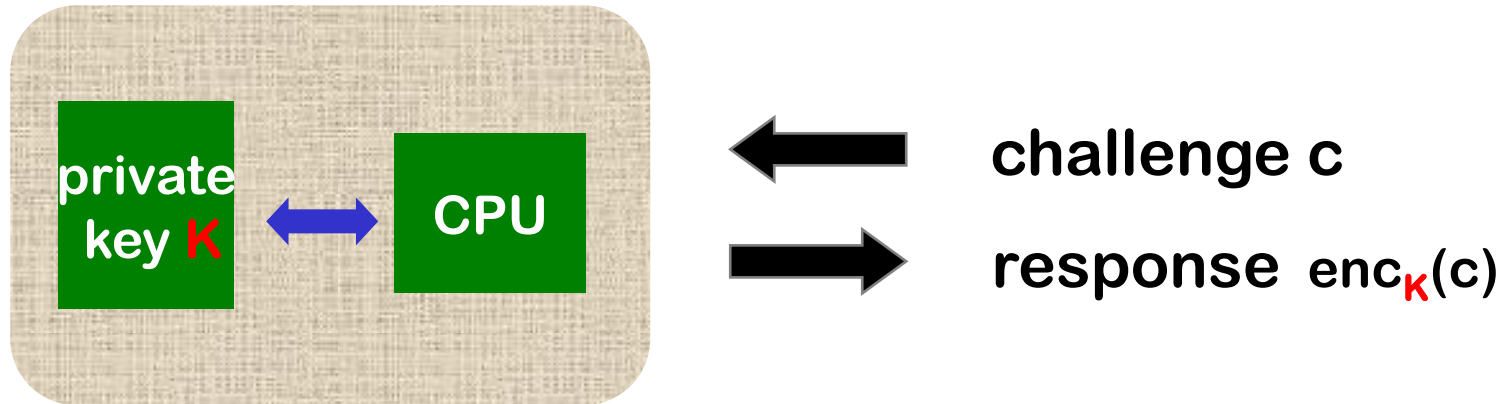

- *If* card can perform encryption, then the private key **K** *never* has to leave the card
- The **card issuer** does not have to trust the **network**, the **terminal**, or the **card holder**
- The card can also **sign** a message using asymmetric crypto, or **compute a MAC** using symmetric crypto.

# Security (critical) functionality in smartcard

- **Crypto:** storing cryptographic keys & executing cryptographic operations
- **Access control** for functionality
  - Eg with a PIN code
  - Incl. functionality to install keys!  
Easy to overlook, but crucial of course...



## Crypto solves some problems

- ensuring **integrity**, **authenticity**, **non-repudiation**, **confidentiality**,...

## but also introduces new problems:

- Where to store keys?
- How to distribute them?
- What hw/sw can we trust to do crypto operations?
- How to ensure **integrity** & **confidentiality** of the cryptographic key?  
Here we will need **access control** again



# Overview of today

- What is a smartcard?
- Hardware, protocols



# What is a smartcard?

- **Tamper-resistant computer**, embedded in piece of plastic, with limited resources
- aka *chip card* or *integrated circuit card (ICC)*
- capable of **securely**
  - **storing** data
  - **processing** data
    - This is what makes a smartcard *smart*, stupid cards can store but not process
    - Processing capabilities vary greatly!

# Smartcard form factors

- **traditional** credit-card sized plastic card

- ISO 7816



- mobile phone **SIM**

- cut-down in size



- **contactless** cards

- aka *proximity card* or *RFID tag*

- also possible: dual interface



# Stupid vs smart smartcards

- **Memory cards (“stupid” smartcards)**
  - essentially just provide a **file system**
  - possibly with some **access control** or, simpler still, **destructive (irreversible) writes** as in old payphone-cards
  - **configurable** functionality hardwired in ROM
- **Microprocessor cards (“smart” smartcard)**
  - contain **CPU**
    - possibly also crypto co-processor
  - **programmable**
    - program burnt into ROM, or stored in EEPROM
- RFID tags are often like old memory cards
- Focus in this course will be on microprocessor cards

# Smart card hardware

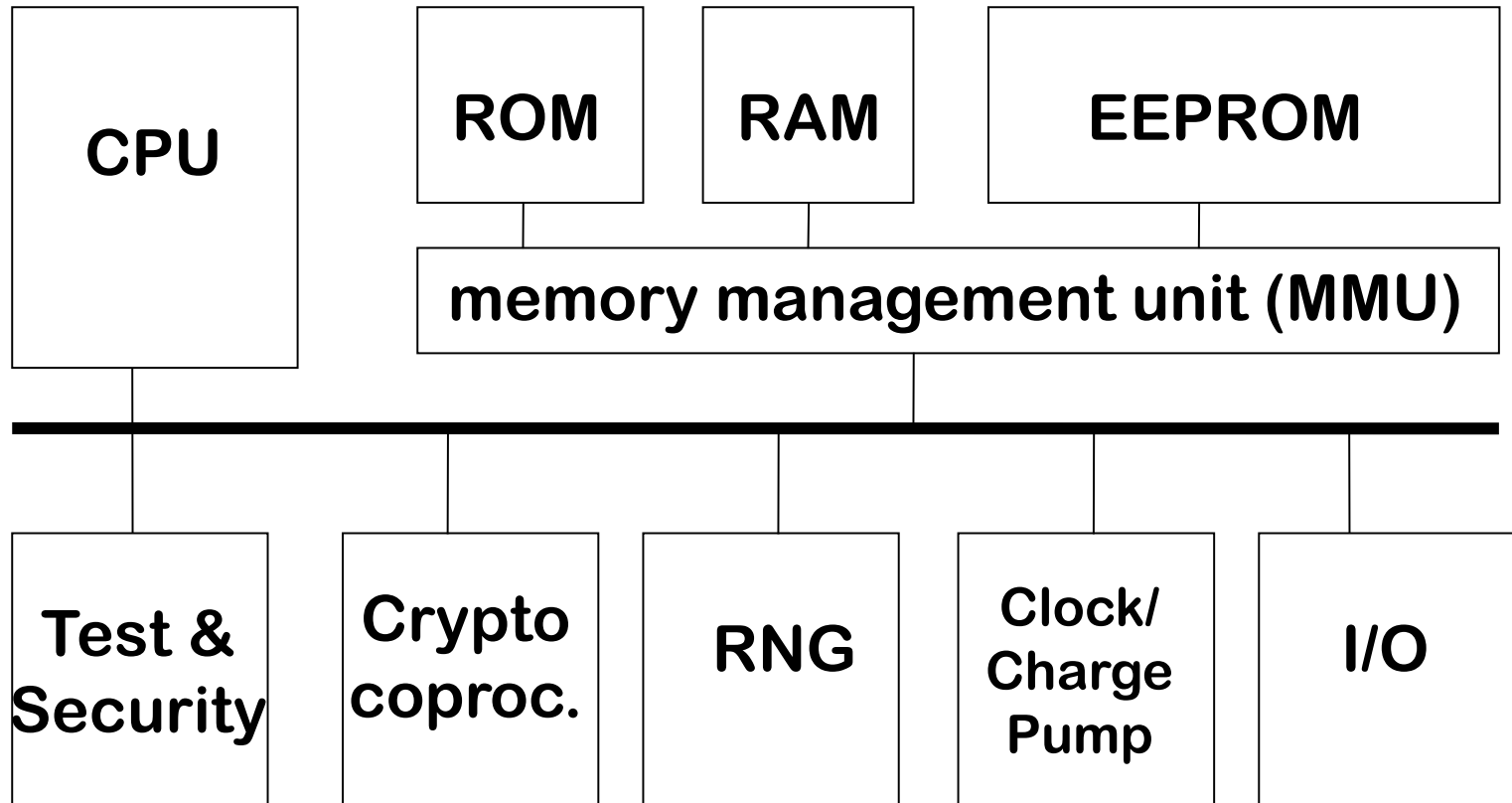

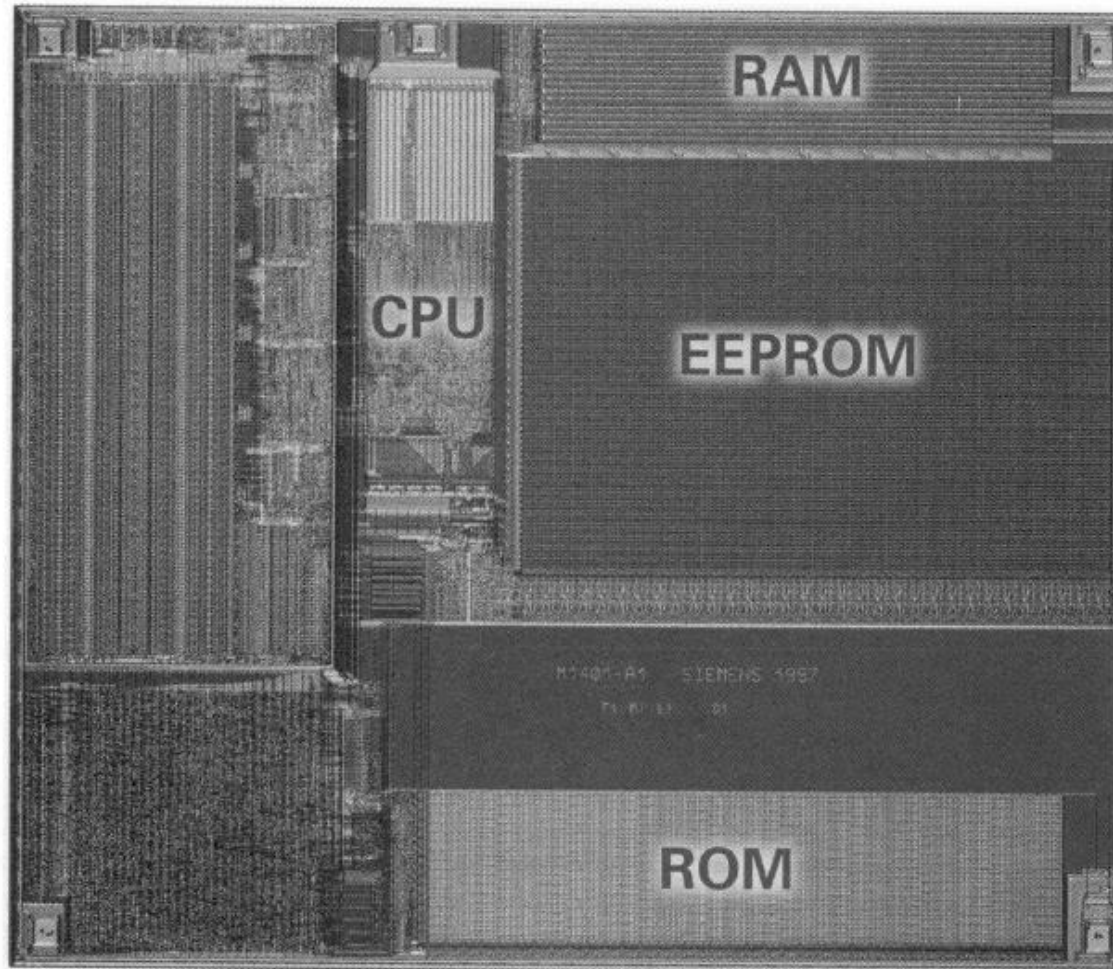

**Figure 3.38** Photo of an SLE 66CX160S Smart Card microcontroller with an area of  $21 \text{ mm}^2$ . This chip was made using  $0.6\text{-}\mu\text{m}$  technology and has 32 kB of ROM, a 16-kB EEPROM and 1280 bytes of RAM. The two unlabeled regions on the left-hand side of the chip are the numeric coprocessor and the peripheral elements (timer, random-number generator and CRC arithmetic processor). The five bonding pads for the electrical connections to the module contacts can be clearly seen in the photo.

# Smartcard hardware

- CPU
- memory
  - volatile (RAM) and non-volatile (ROM+EEPROM)
- limited I/O: just a serial port

Possibly:

- crypto co-processor
- random number generator (RNG)

**No clock, no power!**



# CPU

- 8, 16 and now also 32 bit
- **Steady need for more processing powers**
  - for virtual machines & cryptography

# Cryptographic co-processor

- **DES, AES**
  - DES in hardware takes same size as DES program code in ROM
- For public-key crypto, ALU providing exponentiation and modulo arithmetic with large numbers

# Smartcard memory

## ROM

- BIOS + operating system

## EEPROM

- the smartcard's hard disk

## RAM

- workspace

Typical modern card may have 512 bytes RAM, 16K ROM, 64K EEPROM, 13.5 MHz

# RAM

- **Volatile** aka **transient** memory
- SRAM (static RAM) used rather than DRAM (Dynamic RAM) for lower power consumption
- Used for **temporary data**
  - stack
  - I/O buffer
- *Typically 128 bytes to 16 Kbyte*
- Volatile, but small permanent storage characteristics

## Reading RAM with scanning electron microscope?

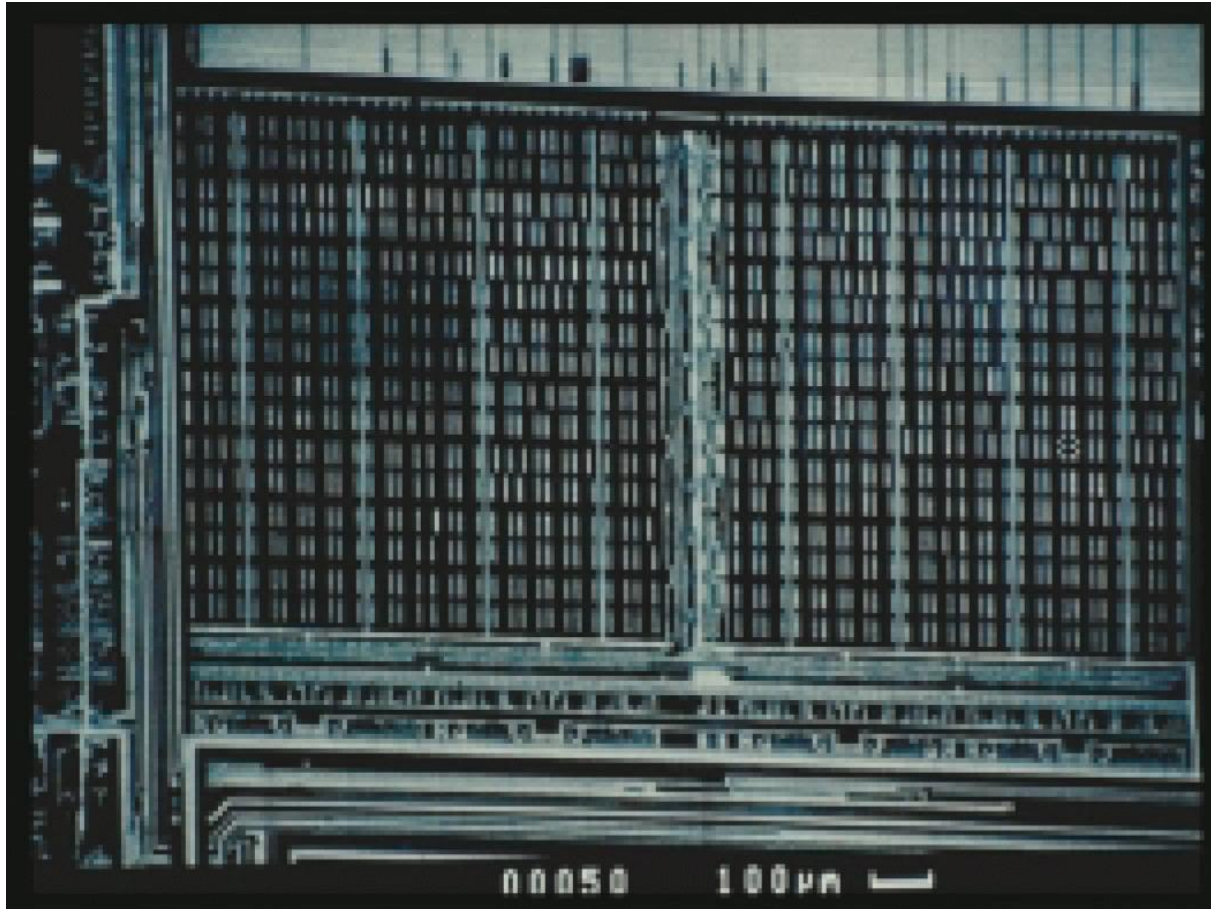

Very tricky, and only if card operates at a low frequency

# ROM

- **Permanent storage**
- **Filled during production, using ROM mask**
- **Contains OS + possibly application code**
- *Typically 8 to 512 Kbyte*
- **Flash is coming up as replacement of ROM**
- **Optically readable after removing top layers**

# Extraction of ROM content

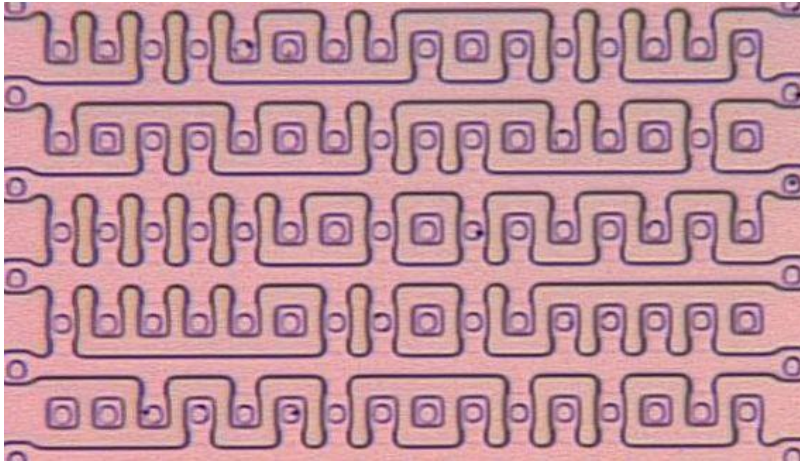

**10x16 bits of NOR ROM**  
visible outlines reveal content

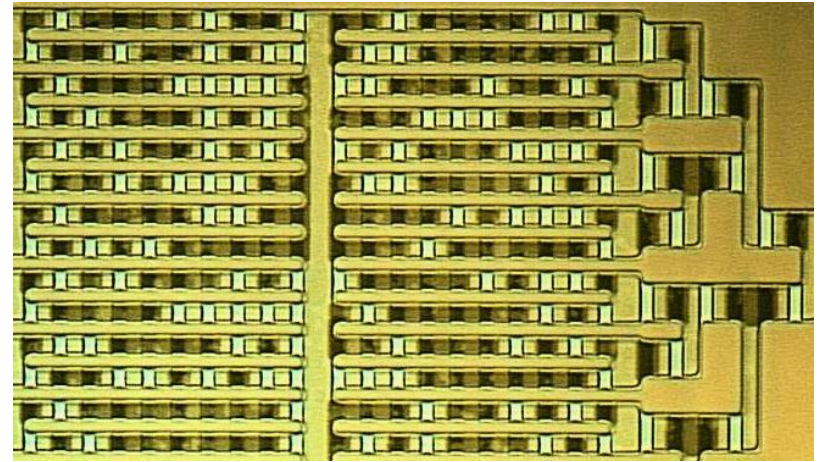

**14x20 bits of NAND ROM**  
after staining, shadows reveal content

[Source: Oliver Kömmerling, Marcus Kuhn]

# Staining for ion implant ROM array

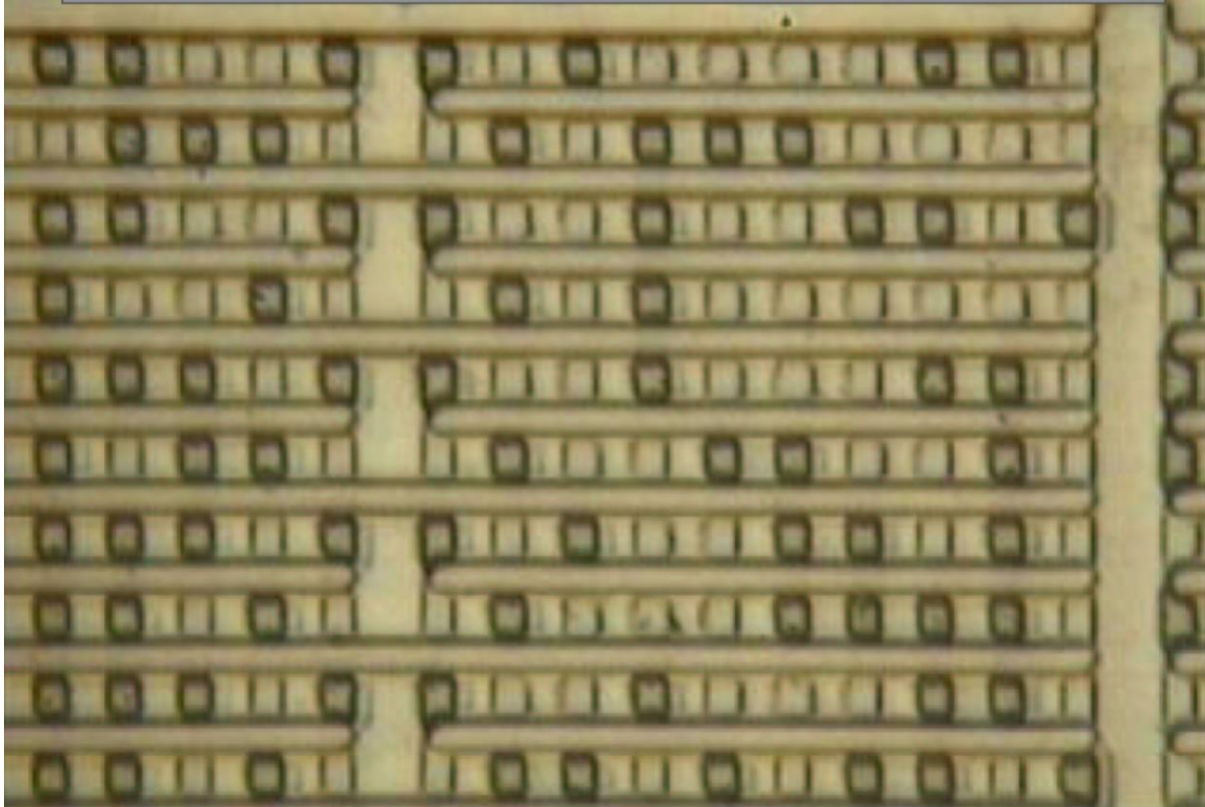

[Source: Brightsight]



# EEPROM

- **Non-volatile** aka **persistent**, rewritable memory
- Used for **applications and data**:
  - "the smartcard's hard disk"
- *Typically 1 to 512 Kbyte*
- **Characteristics**:
  - slow: 1000x slower than RAM
  - has limited lifetime in # writes (but  $> 10^6$ )
  - writing is two stage operation: erase & write
  - data retention 10-100 years
  - **writing takes high power consumption**
    - 17V, realised using charge pump

# ROM vs EEPROM for program code?

Choice between code in ROM or EEPROM has big impact on development

- Program code in ROM must be suitable for mass-use
  - And can *never* be patched or updated
- Trend away from having a lot of code in ROM towards
  - eg just some library code or OS in ROM,  
and all custom functionality (the ‘application’) in EEPROM

# Other non-volatile memory types

## Modern alternatives for EEPROM and ROM

- **Flash**
  - writing 10  $\mu$ s instead of 3 -10 ms for EEPROM
  - programming voltage 12V, against 17V for EEPROM
  - >100,000 writes, >10 years data retention
  - Flash replacing ROM eliminates need for ROM mask & reduces development time
- **FRAM (Ferro-electric RAM)**
  - writing 100 ns
  - programming voltage 5V

# Size matters!

Memory types also vary in **amount of chip surface** per byte:

RAM requires more space than EEPROM,  
EEPROM requires more space than ROM

Size of chip is a major cost factor, hence little RAM

**Size = Money**

# Comparison of memory types

	# of write/ erase cycles	writing time	typical size
RAM	unlimited	70 ns	1700 $\mu\text{m}^2$
EEPROM	$>10^4$ - $10^6$	3-10 ms	400 $\mu\text{m}^2$
Flash	$>10^5$	10 $\mu\text{s}$	200 $\mu\text{m}^2$
FRAM	$>10^{10}$	100 ns	200 $\mu\text{m}^2$
ROM	-	-	100 $\mu\text{m}^2$

source: W. Rankl & W. Effling, Smartcard Handbook, 2<sup>nd</sup> edition, 2000

These numbers give a rough impression, but are outdated !!!

# Memory Management

- **Responsible for allocating memory**
- **Possibly also for some **memory access control**, eg**
  - **between the different types of memory (eg stack, program data, and code)**
  - **between application code and the operating system (OS)**
  - **between applications, for cards that allow multiple applications to be installed**

# Clock circuit & charge pump

- **Charge pump**
  - to generate EEPROM programming voltage
- **Clock circuit**
  - eg. division of the external clock signal to get a lower clock frequency for I/O
- **Typical clock speed 8-13.5 MHz**
- **Esp. for SIM cards: the processor can go into sleep-mode, where clock pulse is stopped, to reduce power consumption**

# Test & Security

- **Self-test hardware & software**
  - checking if all RAM & EEPROM cells work
  - checksums for ROM and static EEPROM
- Possible additional **monitoring and response against attacks**
- Test functionality is a security risk and may partly have to be disabled before personalisation!
  - by writing EEPROM, blowing fuses, or even physically removing hardware



# Random Number Generation (RNG)

- Needed for **key generation** & **fresh nonces**
- Typically **pseudo RNG (PRNG)** in software
  - True RNG that is immune to external influence is hard to realise in hardware
- NB different cards of same production batch should produce *different* sequences of random numbers
  - PRNG using seed (stored in EEPROM) supplied as part of OS initialisation

- *Potential hardware security problem with storing PNRG state in EEPROM?*

*What if this EEPROM wears out after generating lots of random numbers? Card may have to check for this !!*

# NB nonces vs randoms

Many security protocols require the use of **nonces** (numbers only used **once**)

- to **prevent replay attacks** (aka **ensure freshness**)
- **Random numbers** are only one of the ways to generate nonces
- Another way is to simply have **an increasing counter**
  - Eg, your bank cards all use have a counter that is included in integrity & non-repudiation checks
  - Wrapping around after an integer overflow is a security risk for such counters

# Random Number Generation (RNG)

Tested eg according to **FIPS 140-1** which states single stream of 20,000 consecutive bits must pass

- **monobit test**:  $9,546 < \# \text{ ones} < 10,346$
- **poker test**: frequency of 4 bits patterns:
  - divide in 5000 4 bits segments,
  - calculate  $f(p) = \# \text{ of occurrence of 4 bits pattern } p$
  - $1.03 < X < 57.4$ , where  $X$  is  $16/5000 * \sum_p f(p)^2 - 5000$
- **run test**: requirements of runs (sequence of all 0's or all 1's) of lengths 1-6
- **long run test**: no runs  $\geq 34$